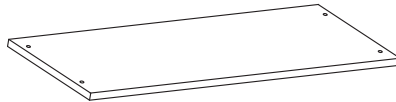
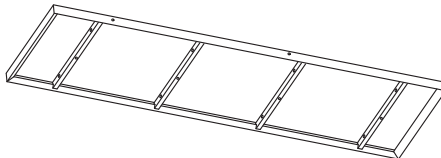

A

4PCS

B

2PCS

C

2PCS

D

4PCS

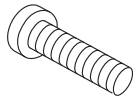
E

M6x25mm

16PCS

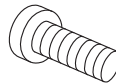
F

M6x15mm

1PC

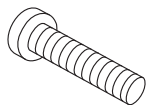
G

M6x40mm

8PCS

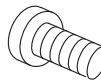
H

M6x12mm

4PCS

I

1PC

J

4PCS

P

1PC

Q

1PC

1

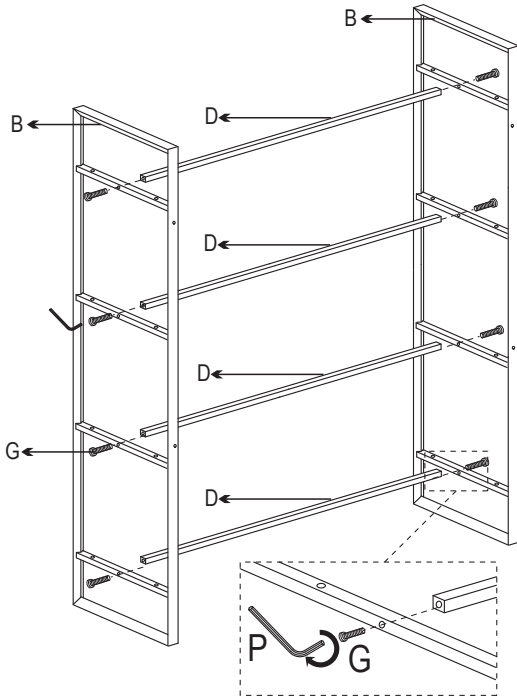

2

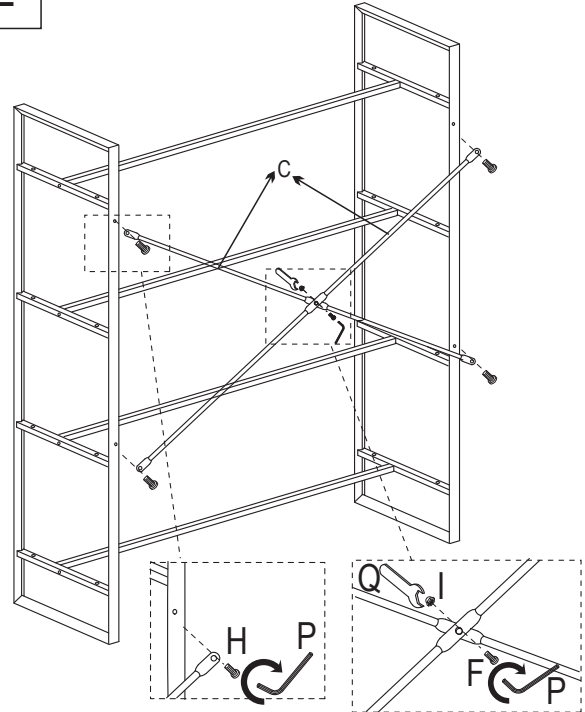



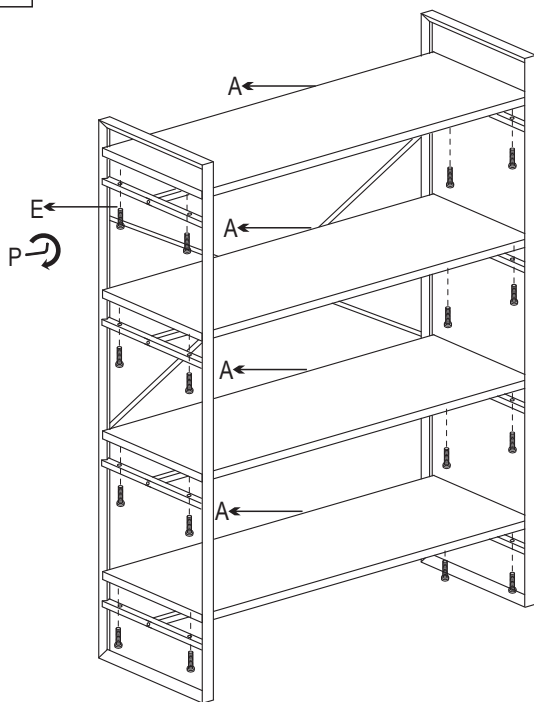

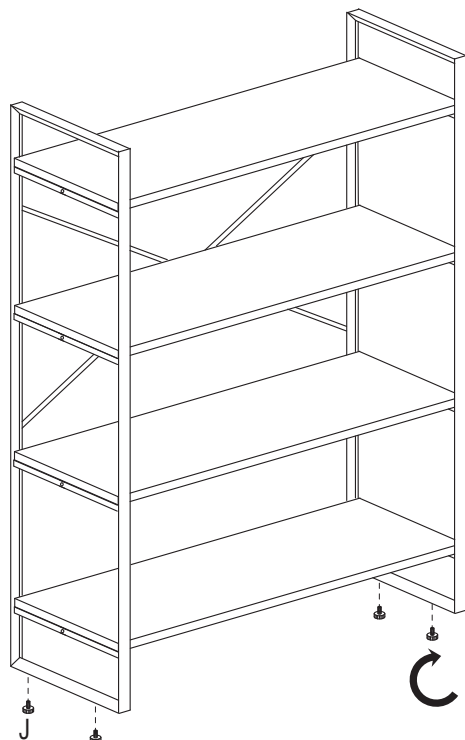

3

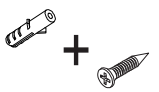

4



O  M4x15mm 4PCS	M  4PCS	K  2PCS	 4PCS			
--	---	---	---	--	---	---

Instrukcja:

MONTAŻ MEBLA DO ŚCIANY JEST ZALECANY PRZEZ PRODUCENTA DLA ZAPEWNIENIA PEŁNEGO BEZPIECZEŃSTWA OTOCZENIA I OSÓB W NIM PRZEBYWAJĄCYCH

- Załączone śruby **O** są wkrętami do drewna i służą jedynie do zamocowania dwóch elementów **M** do mebla.
- Przed montażem pozostałych dwóch elementów **M** do ściany należy zaopatrzyć się w specjalistycznym sklepie w odpowiednie do rodzaju ściany kołki i wkręty, ponieważ nie wchodzi one w skład okuć.
- po zamocowaniu wszystkich elementów **M** należy je ściśle połączyć ze sobą za pomocą elementów **K**.

Wskazówki:

- Wszystkie elementy muszą być zamocowane w sposób zgodny z instrukcją.
- Należy upewnić się, że podłoga jest prosta.
- Mebel powinien zostać odpowiednio wypoziomowany gdyż mocowanie do ściany jest jedynie zabezpieczeniem dodatkowym.

